



Clarus

Exam Lights user manual



CLARUS 4™



CLARUS 7™

THIS PAGE IS INTENTIONALLY BLANK

Table of Contents

APPLICABLE MODEL(S).....	IV
REVISION HISTORY TABLE	IV
GENERAL INFORMATION	1
Purpose of this Manual.....	1
Intended Use.....	1
Symbols and Warnings.....	2
Symboles et Avertissements	2
Safety Instructions	3
Electromagnetic Interference	3
Electrical Requirements	3
Contraindications.....	4
Transportation and Storage Conditions	4
Disposal of Equipment	4
EQUIPMENT FEATURES	4
INSTALLATION	5
Required Tools	5
Unpacking	5
Installation	5
OPERATION	6
Operating Conditions	6
Controls.....	6
LIST OF ACCESSORIES.....	7
MAINTENANCE	7
Cleaning and Disinfection	8
Preventative Maintenance.....	8
Calls for Service.....	8
LIMITED WARRANTY	9
TROUBLESHOOTING GUIDE.....	9
SPECIFICATIONS.....	10

APPLICABLE MODEL(S)

This manual is for the following part numbers and serial numbers.:

PART NUMBER	DESCRIPTION	EFFECTIVE S/N
1000210	Clarus 4 Exam Light w/Caster Base	160310001- Current
1000211	Clarus 4 Exam Light w/Floor Stand	160310001- Current
1000212	Clarus 7 Exam Light w/Caster Base	160310001- Current
1000213	Clarus 7 Exam Light w/Floor Stand	160310001- Current

REVISION HISTORY TABLE

DATE	REVISION	CO#/ECO#	DETAILS
11/26/2014	A	CO-0015/EC-0153	Initial release
4/7/2016	B	CO-0115/EC-0359	Updated instructions for improved neck design of lights.
12/6/2019	C	CO-0187	Revised Proposition 65 warning, updated format/style

User Manual

MTI Clarus 4™ & Clarus 7™

GENERAL INFORMATION

Purpose of this Manual

This manual covers the safety, installation, instructions for use, and maintenance of this equipment. It is intended that it be used by the service professional installing the equipment and by the medical professionals who have been trained to use it. No repair information is included with this manual because no operator repairs are intended.

Intended Use

This equipment is intended to be used as an examination light for general examinations and procedures performed by medical professionals.

PRODUCT INFORMATION

Date of Purchase: _____

Model Number: _____

Serial Number: _____

(see "EQUIPMENT FEATURES" on page 4 for location of serial number label)

Symbols and Warnings

This manual contains Notices, Cautions, and Warnings, which are meant to call attention to particular parts or sections of this manual. Since safety is our first concern, this manual should be read by all personnel who will be operating this medical equipment.

Symboles et Avertissements

Ce manuel contient des avis, des précautions et des avertissements qui sont destinés à attirer l'attention sur des pièces ou des sections de ce manuel particulier. Parce que la sécurité est notre première préoccupation, ce manuel doit être lu par tout le personnel qui sera d'utiliser cet équipement médical.

WARNINGS/AVERTISSEMENTS

Are used to call attention to condition, practice, or procedure which could cause personal injury if not followed correctly. Please become familiar with all warnings and observe them at all times.

Sont utilisés pour attirer l'attention sur une condition, pratique ou procédure qui pourrait causer des blessures s'il n'est pas suivi correctement. S'il vous plaît se familiariser avec tous les avertissements et les observer à tout moment.

CAUTIONS/PRÉCAUTIONS















Are used to call attention to a condition, practice, or procedure which could cause product damage if not used correctly.



Sont utilisés pour attirer l'attention sur une condition, pratique ou procédure qui pourrait causer des dommages au produit s'il n'est pas utilisé correctement.

NOTICES/AVIS

Are used to call attention to helpful information regarding a condition, practice, or procedure.

Sont utilisés pour attirer l'attention sur des informations utiles concernant une condition, pratique ou de procédure.

	Class 1, Type B, Medical Equipment
	Proper shipping orientation for the product Orientation d'embarquement correct pour le produit
	Product is fragile; be careful in handling Le produit est fragile. Soyez prudent lors de la manipulation
	Protective earth ground Terre électrique de protection
	Alternating current Le courant alternatif
	Product must be kept dry Le produit doit rester sèche
	Upper and lower limits of temperature Limites haute et basse de la température
	Indicates the presence of a dangerous voltage/shock hazard Indique le présence de voltage dangereux/ de choc
	Follow instructions for use Suivez les instructions pour l'utilisation
	Identifies the manufacturer's serial number Identifie le numéro de série du fabricant
	Upper and lower limits of relative humidity Limites haute et basse de humidité relative.
	Upper and lower limits of atmospheric pressure Limites haute et basse de la pression atmosphérique
	Connection point for the neutral conductor Point de connexion pour le conducteur neutre
	Live conductor Conducteur sous tension

	<i>(WEEE) Waste of Electrical and Electronic Equipment</i> <i>Déchets d'équipements électriques et électroniques</i>
	<i>UL listing mark</i> <i>Marque UL Listé</i>
RoHS	<i>RoHS Compliant</i> <i>Conforme à RoHS</i>
	<i>Hospital Grade (green dot)</i> <i>De qualité hôpital (point vert)</i>

Safety Instructions

 **WARNING/AVERTISSEMENT**
Read this manual before installation and use.

Lisez ce manuel avant l'installation et l'utilisation.

 **WARNING/AVERTISSEMENT**
No modification of this equipment is allowed.

Aucune modification de cet équipement est autorisé.

 **WARNING/AVERTISSEMENT**
Do not operate equipment in the presence of flammable anesthetics.

Ne pas faire fonctionner l'équipement en présence d'anesthésiques inflammables.

 **WARNING/AVERTISSEMENT**
Assure controls, cords, and other parts of the equipment do not create a tripping or other safety hazard for operator or patient.

Assurer les contrôles, les cordons et les autres parties de l'appareil ne créent pas de déclenchement ou d'autres dangers en matière de sécurité pour l'opérateur ou le patient.

 **WARNING/AVERTISSEMENT**
This product can expose you to chemicals including Antimony Trioxide, which is known to the State of California to cause cancer. For more information go to www.P65Warnings.ca.gov and see www.mti.net/faqs for details on California Proposition 65.

Ce produit peut vous exposer à des agents chimiques, y compris le trioxyde d'antimoine identifiés par l'État de Californie comme pouvant causer le cancer. Pour de plus d'informations, prière de consulter www.P65Warnings.ca.gov et voir www.mti.net/faqs pour les détails sur le Proposition de Californie 65.

Electromagnetic Interference

This equipment is designed and built to minimize electromagnetic interference with other devices. However, if interference is noticed between another device and this equipment, do one or more of the following:

1. Ensure other device is operating within its specifications.
2. Plug equipment into isolated circuit
3. Remove interfering device from room
4. Increase separation between equipment and interfering device
5. Contact MTI if electromagnetic interference persists

Electrical Requirements

 **WARNING/AVERTISSEMENT**

To avoid risk of electrical shock, this equipment must be connected to a supply mains with protective earth.

Pour éviter tout risque de choc électrique, cet appareil doit être branché sur une prise électrique avec la terre électrique de protection.

 **WARNING/AVERTISSEMENT**

Grounding reliability can only be achieved when the equipment is connected to an equivalent receptacle marked "Hospital Only" or "Hospital Grade".

Mise à la terre fiabilité ne peut être atteint lorsque l'appareil est connecté à un réceptacle équivalent marqué "Hôpital Uniquement" ou "de Qualité Hôpital".

 **WARNING/AVERTISSEMENT**

Connecting electrical equipment to multiple socket-outlet effectively leads to creating a medical electronic system and can result in a reduced level of safety.

Connexion d'un équipement électrique à une prise de courant multiple crée un système électronique médicale, et peut entraîner une baisse du niveau de sécurité.

 **WARNING/AVERTISSEMENT**

Equipment must be positioned in normal use such that the power cords can be easily accessed to unplug.

L'appareils doit être positionné en utilisation normale telle que les cordons d'alimentation peuvent être facilement accessibles à débrancher.

 **WARNING/AVERTISSEMENT**

Equipment must be connected to an appropriate power source

User Manual | MTI Clarus 4™ & Clarus 7™ LED Lights

when loss of power source would result in an unacceptable risk.

L'appareils doivent être relié à une source d'alimentation appropriée en cas de perte de la source d'alimentation entraînerait un risque inacceptable.

⚠ WARNING/AVERTISSEMENT

Do not use a two-three plug adapter to plug the equipment into a two conductor outlet, as grounding reliability is not maintained.

Ne pas utiliser un adaptateur non de prise de terre pour brancher l'appareil sur une prise à deux conducteurs, la fiabilité de la terre n'est pas maintenue.

Contraindications



None.

EQUIPMENT FEATURES

Description of Clarus 4 and Clarus 7 LED Exam Lights

The Clarus 4™ is an exam light that comes with a 3" light head with 4 LEDs and the Clarus 7™ is an exam light that comes with a 3 1/2" light head with 7 LEDs. They can be mounted on a caster base or floor stand. The expected position of the operator is to the front of, to the side of, or behind the light. The expected position of the patient is below/underneath the light head.

Transportation and Storage Conditions

	Ambient Temperature	+10°C to +40°C (+50°F to +104°F)
	Relative Humidity	30% to 75% (non-condensing)
	Atmospheric Pressure	700hPa to 1060hPa (0.69atm to 1.05atm)

Disposal of Equipment

At the end of product life, the equipment, accessories, and other consumable goods may have become contaminated due to normal medical use. Consult local codes and ordinances for proper disposal of equipment, accessories and other consumable goods.

CLARUS™ LED LIGHT

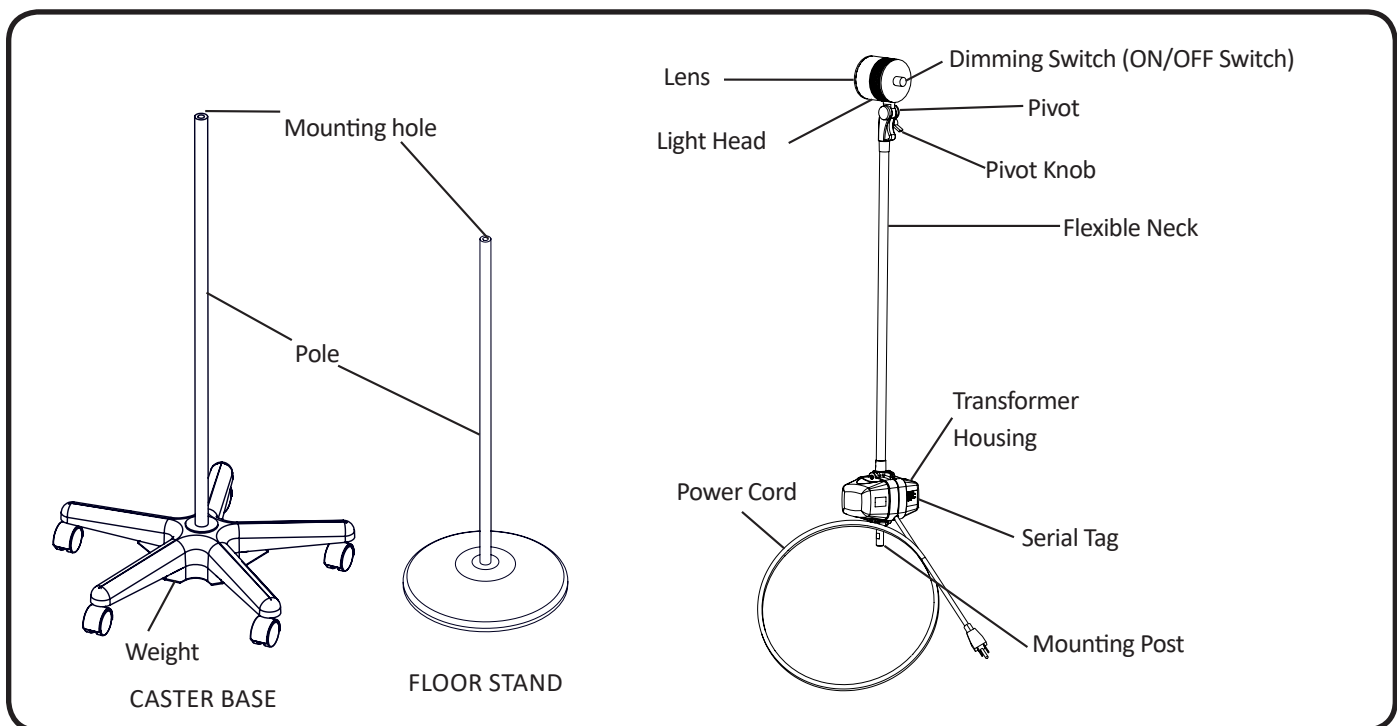

INSTALLATION

CAUTION/PRÉCAUTION

To move equipment, lift only from the equipment's main structure.

Pour déplacer l'appareil, soulevez seulement de la structure principale de l'appareil.

NOTICE/AVIS

If this product has been exposed to low temperatures, allow adequate time for it to warm to room temperature before putting it into service.

Si ce produit a été exposé à de basses températures, laisser suffisamment de temps pour lui permettre de se réchauffer à température ambiante avant de le mettre en service.

NOTICE/AVIS

Inspect the shipping boxes for visible damage. Record on bill of lading, photograph, and report any damage to the carrier immediately. Request an inspection by the carrier if any concealed damage is noted.

Inspectez les boîtes d'expédition pour les dommages visibles. Fiche sur le connaissance, prendre une photo, et signalez les dommages dûs au transporteur immédiatement. Demander une inspection par le transporteur en cas de dommage caché est noté.

Required Tools



Unpacking

Open the boxes with the utility knife and remove all contents from the packaging.

Installation

The Clarus 4™ and Clarus 7™ can be purchased with either a caster base or a floor stand. The assembly instructions for the caster base and floor stand are provided in their box.

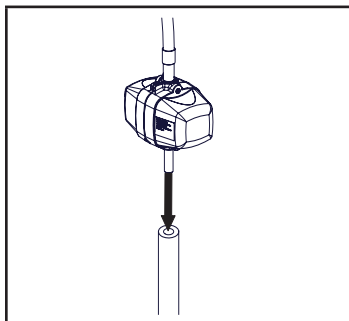

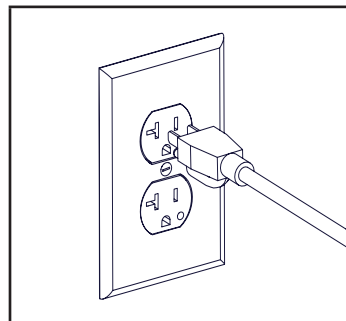

1. To assemble the Clarus 4™ or Clarus 7™ to the caster base or floor stand: Insert the mounting post of the light into the hole in the top of the caster base or floor stand.



2. Plug the power cord into an appropriately marked receptacle.

OPERATION

Operating Conditions

	Ambient Temperature	+10°C to +40°C (+50°F to +104°F)
	Relative Humidity	30% to 75% (non-condensing)
	Atmospheric Pressure	700hPa to 1060hPa (0.69atm to 1.05atm)

Controls

CAUTION/PRÉCAUTION

Once the dimmer switch hits a stop in either the clockwise or counterclockwise direction, do not turn the dimmer switch further, otherwise the product may be damaged.

Une fois que le variateur de lumière frappe un arrêt soit dans le sens horaire ou antihoraire, ne pas tourner le variateur de lumière plus loin, sinon le produit risque d'être endommagé.

On/Off and Brightness Control

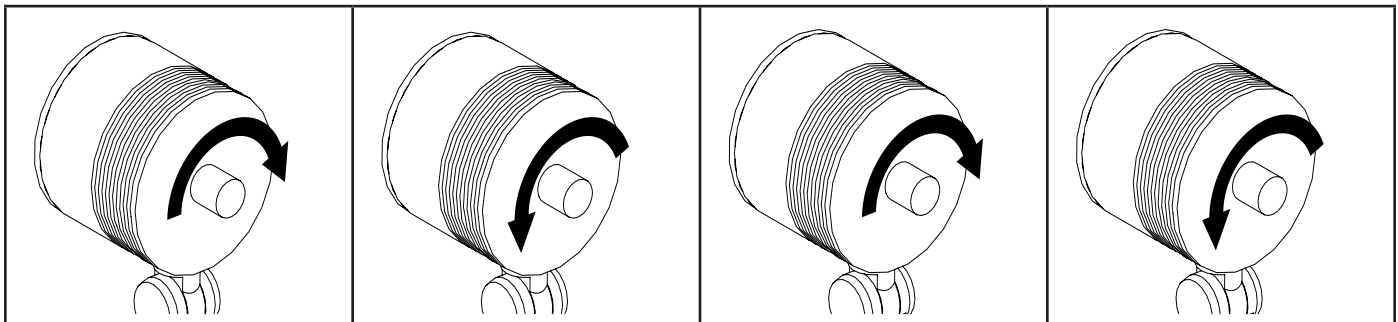

1. To turn the light on, turn the ON/OFF switch clockwise. You will hear a click when the switch turns on.

2. To turn the light off, turn the ON/OFF Switch counter clockwise. You will hear a click when the switch turns off.

3. To brighten the light, turn the dimming switch clockwise to the desired brightness.

4. To dim the light, turn the dimming switch counterclockwise to the desired brightness.

Flexible Neck

The MTI Clarus lights have a flexible neck to position the light head in the desired position.

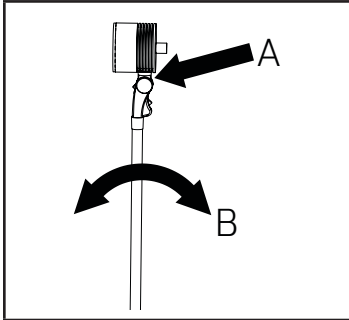

1. To move the light:
 - A. Grasp the neck below the head of the light.
 - B. Move it to the desired position.

Pivot Head

The MTI Clarus lights have a pivot head, which has a 160° vertical and 180° horizontal rotation.

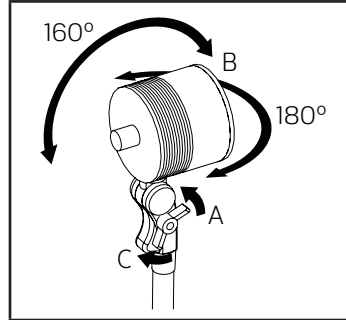

1. To pivot the light head:
 - A. Slightly loosen the pivot knob by turning it counter-clockwise 1/8 of a turn.
 - B. Rotate the light head to the desired position.
 - C. Tighten the pivot knob by turning it clockwise.

CAUTION/PRÉCAUTION

Do not force the light head beyond the rotational stop or rotate the head more than 180° horizontally; otherwise, the light head will be damaged.

Ne pas forcer la tête de la lampe au-delà de l'arrêt de rotation, ou faire tourner la tête de plus de 180° horizontalement sinon la tête de la lampe sera endommagé.

LIST OF ACCESSORIES

DESCRIPTION	USE	RESTRICTIONS
None		

MAINTENANCE

WARNING/AVERTISSEMENT

There are no user serviceable parts inside. Refer all servicing to a qualified service technician.

Aucune pièce interne ne peut être réparée par l'utilisateur. Adressez-vous à un technicien qualifié.

WARNING/AVERTISSEMENT

The Control of Hazardous Energy (lockout/tag out) §1910.147 procedure must be followed to disable equipment, preventing the release of hazardous energy while performing servicing and maintenance activities.

La procédure de La Maîtrise des Énergies Dangereuses (lockout/ déconsignation) § 1910.147 doit être suivie pour désactiver l'équipement, empêchant la libération des énergies dangereuses lors de l'exécution des activités de maintenance et d'entretien.

CAUTION/PRÉCAUTION

This equipment may be damaged by solvents and dyes. Immediately remove any fluids spilled on the equipment.

Cet équipement peut être endommagé par des solvants et des colorants. Retirer immédiatement tout liquide renversé sur l'équipement.

CAUTION/PRÉCAUTION

Any sprayed disinfectant or cleaning solution should be wiped up immediately after application and not let to stand. A small sample area should be tested before any large application of any cleaner/disinfectant.

Tout désinfectant pulvérisé ou solution de nettoyage doivent être essuyés immédiatement après l'application et ne pas laisser reposer. Une petite zone de l'échantillon doit être testé avant toute application complète d'un nettoyant/désinfectant.

CAUTION/PRÉCAUTION

Avoid prolonged direct sunlight exposure to preclude color change of the plastic.

Évitez l'exposition directe au soleil prolongée pour empêcher le changement de couleur des éléments en plastique.

NOTICE/AVIS

MTI recommends cleaning the equipment frequently.

MTI recommande de nettoyer l'appareil fréquemment.

Cleaning and Disinfection

MTI's standard policy on disinfecting MTI medical equipment is to use a 10% sodium hypochlorite (bleach) and 90% water solution. If stronger or other disinfecting and cleaning solutions are used, the surface is at risk to be damaged or possibly cause discoloring, cracking, or other types of damage to the surface. See current CDC Guideline for Disinfection & Sterilization in Healthcare Facilities.

MTI understands that many customers prefer to use a pre-mixed disinfecting solution in a spray or wipe. It is MTI's recommendation not to use sprays because over time the overspray will cause damage to the surfaces if not immediately wiped up. MTI recommends hand towels or wipes to avoid the possibility of overspray. Once the approved contact time has been obtained, remove and dry excess liquid remaining on the surface.

See "MTI Cleaning Solution Recommendation Letter" for more details on disinfecting solutions which have been tested on MTI's products. It is available for download at www.mti.net/disinfectantpolicy. Or, in the U.S. & Canada, call (888) 520-4998, or International, call (801) 875-4998 to request a copy.

Painted and Plastic Surfaces

All painted metal parts have been electrostatically painted and the paint is baked on for durability. These surfaces should be wiped down with a quality grade cleaner and a soft cloth or a damp cloth with mild soap once a week.

Preventative Maintenance

Periodically inspect the following areas:

1. All fasteners and pins should be in place and tightened securely.
2. Lubricate pins and moving joints as needed with lithium grease.
3. Power cord should be free of cuts or other visible damage.
4. All mechanical functions should operate properly.

Have an authorized service technician inspect your equipment once a year.

Calls for Service

Equipment's model and serial number information are required when calling for service.

Serial number is indicated by the  symbol located on the serial number tag.

If service is required, contact MTI

U.S. & Canada 888-520-4998

International 801-875-4998

Fax (801) 952-0548

customer.service@mti.net

Monday-Friday 8:00 am - 5:00 pm (MST)

www.mti.net



LIMITED WARRANTY

Medical Technology Industries, Inc. (hereinafter referred to as MTI), shall repair or replace products of its manufacture, which prove to be defective in material and/or workmanship for a period of twelve (12) months from the date of shipment to the customer (the "Warranty Period"). MTI will, at its option, provide parts to the customer or repair the defective part at MTI's factory or authorized repair facility. Except as it may otherwise specifically agree in writing, MTI shall not be liable for transportation or labor charges for repairs or adjustments or other work done on any of its products by MTI's authorized dealers or service organizations.

Customer shall notify MTI of any alleged claim or defect within fourteen (14) days from the date customer discovers, or upon reasonable inspection should have discovered, such alleged claim or defect (but in any event before the expiration of the Warranty Period). All repair parts are warranted for Ninety (90) calendar days from the date of shipment to the customer. Warranty is non-cumulative.

This warranty does not apply to any part or product which upon examination by MTI or its authorized agents indicates the product

has been repaired or altered in any way by persons other than MTI or its authorized agents, has been misused, abused or used in a manner contrary to any instructions issued by MTI. Any parts or products claimed under this warranty must be properly packaged by customer and returned to MTI's factory with no liability to MTI for the parts, products or transportation charges thereon.

In no event, shall MTI have any liability for consequential, indirect, incidental, special, exemplary, punitive or enhanced damages, lost profits or diminution in value arising out of or relating to a product defect or the repair or replacement of any products manufactured or sold by it.

THE FOREGOING LIMITED WARRANTY IS MADE IN LIEU OF ALL WARRANTIES EXPRESSED OR IMPLIED, AND MTI MAKES NO OTHER WARRANTY WHATSOEVER WITH RESPECT TO THE PRODUCTS INCLUDING BUT NOT LIMITED TO, ANY IMPLIED WARRANTY OR MERCHANTABILITY OR FITNESS FOR A PARTICULAR PURPOSE.

TROUBLESHOOTING GUIDE

NOTICE/AVIS

For more information on this equipment, including circuit diagrams, parts and service manuals, and other descriptions, please contact MTI.

Pour plus d'informations sur cet équipement, y compris des schémas de circuits, les manuels de service et pièces, et autres descriptions, s'il vous plaît contacter MTI.

#	SYMPTOM	PROBLEM CAUSE	SOLUTION
1	Light does not turn on.	Light is not plugged in.	Verify power cord is securely connected to facility power supply.
2	Light does not turn on.	Facility supply voltage	Check facility's power receptacle with a known working device.
3	Light does not turn on.	Facility supply voltage	Reset facility circuit breaker.
4	Lights do not dim/brighten.	Faulty dimmer switch	Contact MTI for replacement light.

SPECIFICATIONS

DESCRIPTION	CLARUS 4™ SPECIFICATIONS	CLARUS 7™ SPECIFICATIONS
Number of LEDs	4 White LEDs	7 White LEDs
LED Life	40,000 hours	40,000 hours
Color Temperature (CCT)	4,300° K , ±300° K	4,300° K , ±300° K
Working Distance	12" (30.5 cm)	16" (40.6 cm)
Light Intensity	21,500 lux (2,000 fc)	33,400 lux (3,100 fc)
Spot Size	3" (7.6 cm) dia	8" (20.3 cm) dia
Color Rendering Index (CRI)	75	75
Dimming Control	Infinitely adjustable 25-100% of full intensity	Infinitely adjustable 25-100% of full intensity
Electrical Input/Consumption	100-240 VAC, 50–60Hz, 40W @ 3.3A	100-240 VAC, 50–60Hz, 40W @ 1.67A
Head Rotation	160° vertical and 180° horizontal	160° vertical and 180° horizontal
Mounting Options	Caster Base and Floor Stand	Caster Base and Floor Stand
Power Cord	3-wire grounded NEMA 5-15P Hospital Grade , 8' (2.44 m) long	3-wire grounded NEMA 5-15P Hospital Grade , 8' (2.44 m) long
Physical Dimensions: Head Diameter Height Base Diameter	3" (7.6 cm) Caster Base: 73" (185.4 cm) Floor Stand: 71" (180.3 cm) Caster Base: 23.75" (60.3 cm), Floor Stand: 15" (38.1 cm)	3.5" (8.9 cm) Caster Base: 73.5" (186.7 cm), Floor Stand: 71.5" (181.6 cm) Caster Base: 23.75" (60.3 cm), Floor Stand: 15" (38.1 cm)
Shipping Dimensions: Light (doesn't include base or stand) Caster Base Floor Stand	35" x 8" x 7" (88.9 cm x 20.3 cm x 17.8 cm) 4" x 32" x 24" (10.2 cm x 81.3 cm x 61 cm) 4" x 38" x 16" (10.2 cm x 96.5 cm x 40.6 cm)	35" x 8" x 7" (88.9 cm x 20.3 cm x 17.8 cm) 4" x 32" x 24" (10.2 cm x 81.3 cm x 61 cm) 4" x 38" x 16" (10.2 cm x 96.5 cm x 40.6 cm)
Shipping Weight: Light (neck and head only) Caster Base Floor Stand	4.5 lbs (2 kg) 19.5 lbs (8.85 kg) 29.5 lbs (13.4 kg)	5 lbs (2.3 kg) 19.5 lbs (8.85 kg) 29.5 lbs (13.4 kg)
Warranty	1-year limited	1-year limited
Listings	UL 153 UL 8750 CAN/CSA C22.2 No. 12	UL 153 UL 8750 CAN/CSA C22.2 No. 12

THIS PAGE IS INTENTIONALLY BLANK



Strength in patient care.™

MTI, Inc.
3655 W Ninigret Drive
Salt Lake City, Utah, 84104-6572
800-924-4655 • 801-875-4999 • Fax 801-952-0548
www.mti.net

© MTI All rights reserved. MTI reserves the right to make any product changes without notice. The MTI brand and Bear logo design are registered trademarks of MTI, Inc. in the United States.

073094 Rev C